

G-100/200 Operation & Installation

Contents

- 7** **Installation**
- 15** **Getting Started**
 - 16 GPS Mode Setup
 - 18 Wheel Sensor Mode Setup
 - 20 Fuel Calibration
- 23** **Basic Operation**
 - 24 Telemetry Screen
 - 27 Entering a Distance
 - 28 Measurement Units
 - 28 Turning On & Off
- 29** **Advanced Features**
 - 30 Customising the Telemetry Screen
 - 31 Using the Sprint Timer
 - 34 Auxiliary Inputs
 - 35 Stage Recorder
- 39** **Troubleshooting**

GPS+ Overview

The G-100/200 can measure distance and speed using either the GPS signal or a traditional wheel speed sensor. For most customers GPS alone will provide excellent results with accuracy comparable to a well calibrated wheel sensor.

However, like any GPS system, accuracy can be degraded when operating in heavily built-up areas or under dense forest cover. To address this limitation the G-100/200 includes unique GPS+ sensor fusion technology. This works by combining the output signals from a wheel sensor and the GPS receiver. While the GPS signal is available the GPS+ software continuously calibrates the wheel sensor in the background. If the GPS signal is subsequently lost operation is automatically switched to the wheel sensor. The result is uninterrupted high accuracy operation in any environment without the need to manually calibrate a wheel sensor.

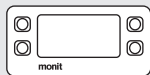

GPS Only

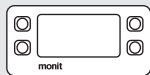
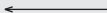

Wheel Sensor Only

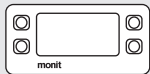
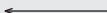
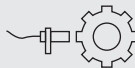

GPS+ Sensor Fusion
Mode

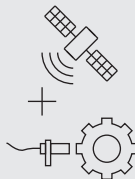

Note: To use the GPS+ function simply install a wheel sensor as well as the GPS antenna. The software will automatically detect the sensor.

Installation

Warning:

Installation of the G-100/200 may require modifications to be made to your vehicle's electrical system. If this is not done correctly, expensive damage may be caused to both the product and your vehicle. It is strongly recommended that you seek the services of a qualified automotive electrician to carry out this work.

Step 1: Before You Start

Check that you have the items shown below. You will also need a selection of tools, wiring equipment, and a suitable place to work.

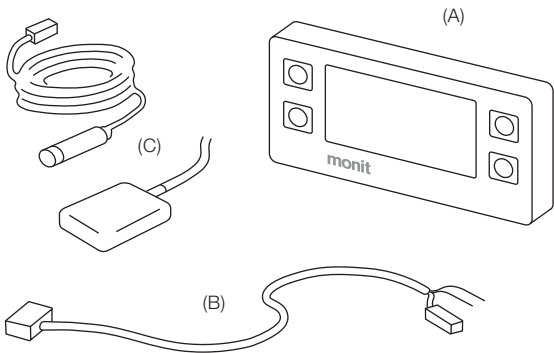

(A) Rally Computer (B) Wiring Loom

(C) GPS Antenna and/or Wheel Speed Sensor (ref. page 4)

Step 2: Fitting to the Vehicle

Securely attach the rally computer to the interior of your vehicle. The most common locations for this are either on the dashboard directly in front of the co-driver or on the passenger door frame.

When fitting the device, ensure that:

- It will not come free of its mounts during an accident. There are two M4 bosses on the back that can be used to fasten it securely.
- It does not interfere with any of the vehicle's safety equipment.
- The co-driver can operate it comfortably while seated.

Warning: If the vehicle still has airbags fitted, do not place the device over the covers from which these are deployed. Doing so could result in serious injury in the event of a collision.

Step 3: Electrical Connections

The G-100/200 connects to your vehicle's electrical system through the color-coded wiring loom supplied with it. Connect this loom as shown.

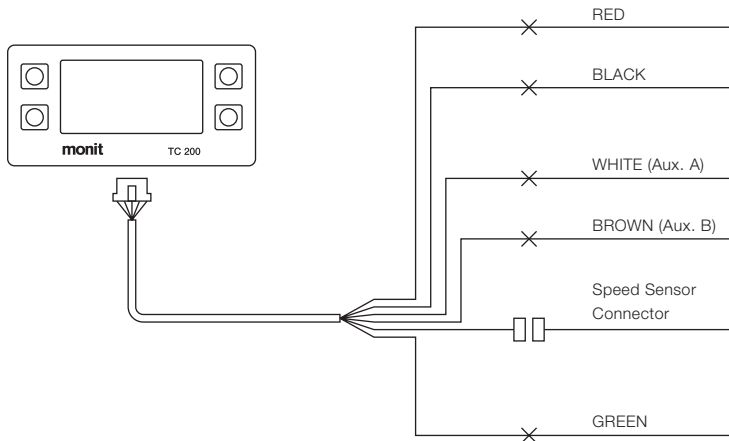

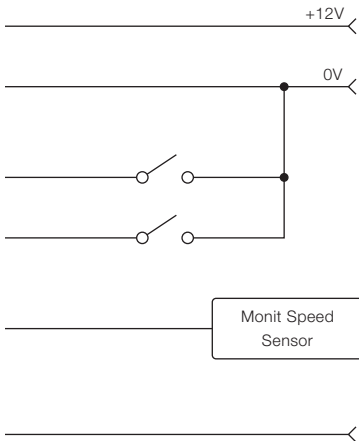

Installation

Connect to a 12 Volt power source that is able to supply power even when the ignition is turned off.

Use a common ground point for all parts of the circuit. Do not use the vehicle's chassis.

(Optional) Attach up to two hand or foot switches to use the Auxiliary Inputs. See Page 11 for more details.

(Optional) Wheel Sensor Connector Details:
 BLUE - Signal
 ORANGE - +5V
 BLACK - 0V

(G-200 only) Connect to the output of your vehicle's fuel sender.

GPS Antenna

If GPS is going to be used to measure speed and distance you will need to fit a suitable antenna. There is a range of these available from Monit. The antenna attaches to the device using the SMA connector on the back. Refer to the information supplied with your antenna for detailed instructions.

Wheel Speed Sensor

If GPS is not going to be used, or you want to make use of the GPS+ sensor fusion technology (see Page 4), you will need to supply a wheel speed signal to the rally computer. There is a special connector on the wiring loom for this purpose. It will connect directly to the range of wheel sensors available from Monit, and detailed installation instructions are supplied with each sensor.

Auxiliary Inputs

These can be used to attach up to two hand or foot switches to the unit. You can then configure each switch to perform a range of useful functions, such as clearing the distance or controlling the stopwatch. For most functions a normally-off momentary type switch should be used.

See page 28 for more information.

Fuel Sender Signal (G-200 only)

To use the G-200's fuel measurement system, connect the output signal from your vehicle's fuel sender directly to the green wire on the loom.

Points to note during installation are:

- The G-200 works by measuring the output voltage of your vehicle's fuel sender. It can be used with signals that either rise or fall with increasing fuel level.
- If you remove your factory fuel gauge you will need to fit a resistor of approximately the same value in its place to power the sender.
- Many factory fuel senders will not produce an output signal when the ignition is turned off.

Step 4: Final Checks

Before you apply power to the system check that all your electrical connections are correct. Also make sure that any exposed wires in the circuit are covered with insulation tape or heat-shrink so they will not short against the chassis.

Getting Started

The G-100/200 has an easy to use graphical user interface that makes operation simple and efficient. Read through this section to learn how to quickly setup and configure the unit after powering it up for the first time.

GPS Mode Setup (default)

Once you have finished installing the unit and GPS antenna apply power to the unit to start it up. The first menu to appear will prompt you to select an operating language (you can change this later on). Following this the main telemetry screen (see page 24) will appear.



Before any measurements can be made the GPS receiver must first obtain a satellite signal lock. To indicate the status of this process an icon is shown in the lower left corner of the telemetry screen. This flashes 'GPS' when no lock is available and changes to 'GPS' once a signal lock is obtained. Once lock is established the G-100/200 is ready to use.

Notes:

- During initial power up (cold start), or if the unit has been disconnected for a long period of time, it may take up to 12 minutes to obtain an initial satellite lock.
- If GPS+ sensor fusion technology is being used, the wheel sensor will be used while GPS lock is being obtained to provide uninterrupted operation.

You can view the status of the GPS system by navigating to the 'GPS Setup' item in the main menu.

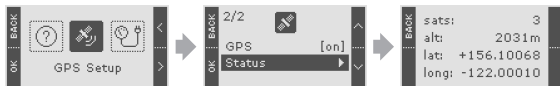

Wheel Sensor Mode Setup

If you only want to use a traditional wheel sensor instead of the GPS system to measure distance and speed you will have to disable the GPS receiver and then perform a calibration of the wheel sensor against a known distance before the unit can be used.

To disable the GPS receiver, select 'GPS Setup' in the main menu and toggle the 'Enable' option to the off position.

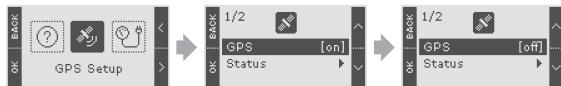

If you already know the pulse/km calibration value for your vehicle, you can also enter this value manually. Refer to page 36 for details.

Distance Calibration

If the GPS is not being used, you will need to perform a calibration of the wheel speed sensor before it can be used. The device includes a special calibration wizard that guides you through this process using simple on-screen instructions.

To calibrate the distance (only possible if GPS is disabled):

1. Find a piece of road with an accurately known distance. Use a distance of at least one mile/kilometre for best results.
2. From the Main Menu select Calibration > Cal. Distance to start the calibration wizard.
3. Follow the instructions on the screen.

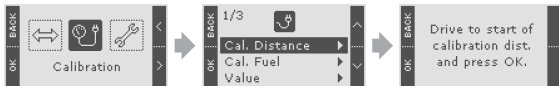

Note: The device will not lose its calibration if the power supply is disconnected.

Fuel Calibration (G-200 only)

The G-200's fuel measurement system is designed to work with a wide range of tank sizes and shapes. Before it can be used, the system must be calibrated to suit your particular vehicle. This is done using a special calibration wizard that guides you through the process using simple on-screen instructions.

To calibrate the fuel system:

1. Find a safe place to add and remove fuel from your vehicle. To perform the calibration, you will need enough fuel to fill the tank completely and a 5-10 litre container that you can use to measure the amount of fuel being added.
2. Empty all the fuel from the tank.
3. From the Main Menu select Calibration > Cal. Fuel to start the calibration wizard.
4. Follow the instructions on the screen.

The calibration wizard works by recording a number of set points as you add fuel to the tank. For best results:

- Use at least five set points (up to a maximum of ten).
- Add about 5 to 10 litres of fuel between each point

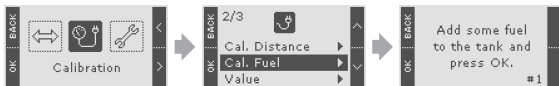

Notes: Many vehicles will not give a correct fuel signal unless the ignition is turned on. The device will not lose its calibration if the power supply is disconnected.

Basic Operation

This section contains information about the features you will most often use while on a rally event. Read through it to familiarize yourself with the product's main functions and to ensure you get the best out of it while out on a rally stage.

Telemetry Screen

This is the main screen that appears when the rally computer is powered up and is the one you will use most often while on events. It allows you to easily view your vehicle's distance, speed, timing and fuel information.



The upper half of the menu always shows the Interval Distance Counter which can be reset by pressing the upper right CLR button. The lower half is used to show all other speed, distance, timing and fuel parameters for your vehicle. Use the MODE button to cycle through each of these. The parameters available are described on the next page.



Total Distance Counter

Second distance counter. Hold the CLR button down for one second to reset.



Current Speed

The current vehicle speed in kph or mph.



Average Speed (G-200 only)

The average vehicle speed since the function was last reset. This includes any time spent stationary. Hold the CLR button down for one second to reset.



Maximum Speed

The maximum vehicle speed. Hold the CLR button down for one second to reset.



Stopwatch

Integrated stopwatch. Use the STRT button to start and stop timing. Hold the same button down for one second to clear the time.



Time of Day (G-200 only)

The current time in 24-hour format. Use the SET button to adjust the value.



Fuel (G-200 only)

The current fuel level in litres or gallons. When the vehicle is moving the value may fluctuate as the fuel in the tank moves about.

To reduce clutter, you can disable parameters that you do not want to use. See page 30 for more information.

Note: Some parameters are disabled by default. You will need to enable them before they can be selected using the MODE button.

Entering a Distance

In some situations you may want to set one of the distance counters to a particular starting value. To do this:

1. Select the Set Distance menu.
2. Choose the counter (Interval or Total) that you want to set.
3. Enter the new value. Use the '+' and '-' buttons to adjust the highlighted digit and the '>' button to move between digits. When the last digit is reached press the SET button to finish.



The Set Interval menu can also be accessed by holding down the interval distance CLR button (top right) for three seconds when in the Telemetry Screen.

Measurement Units

The device can display distance and fuel information in a number of different measurement units. To change this select Settings > Units. The device does not need to be re-calibrated when these settings are changed.

Backlight Intensity

When in the Telemetry Screen the intensity of the backlight can be reduced by holding down the MENU button for one second. Repeating this will return it to full brightness. It can also be adjusted by selecting Settings > Backlight.

Turning On & Off

The device turns off automatically after five minutes of inactivity. Press any of the buttons or start moving the vehicle to turn it on again. This timer can be disabled if required (see page 37).

Advanced Features

Once you've mastered the basic functions of the G-100/200, read this section to learn about its more advanced features. Customise the user interface, setup a foot switch and measure the performance of your vehicle—quickly and conveniently.

Customising the Telemetry Screen

The lower half of the Telemetry Screen can be used to display up to seven different speed, distance, timing and fuel parameters. To reduce clutter the device allows you to select which parameters you want to use.

To enable or disable a parameter select Settings > Telemetry. A list of available parameters will appear and selecting one will toggle its status on and off.

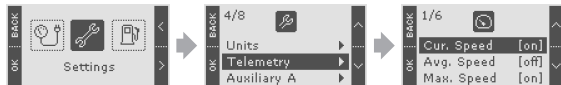

Sprint Timer

The built-in Sprint Timer can be used to accurately measure your vehicle's 0-100kph (0-60mph) and 0-400m (1/4 mile) * acceleration times.

To use the Sprint Timer:

1. Select the Performance menu.
2. Choose the type of sprint you want (0-100kph or 400m*).
3. Bring the vehicle to a halt and press OK to arm the system.
4. The timer will start automatically when the vehicle starts moving. When the target speed or distance is reached it will stop and display the acquired time.



* Available on G-200 model only.

Auxiliary Inputs

The two Auxiliary Inputs can be used to attach external hand or foot switches to the rally computer. These can then be configured in software to perform one of the tasks shown in the table on the next page.

To assign a task to an input:

1. Select the Settings menu.
2. Select Auxiliary A or Auxiliary B (depending on which switch you want to configure).
3. Select the task you want from this list and press OK.

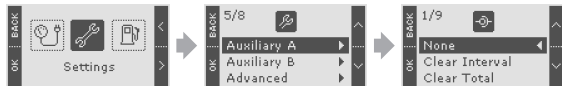

Task Name	Description
None	The Auxiliary Input is not used.
Clear Interval	Clears the Interval Distance.
Clear Total	Clears the Total Distance.
Pause	Toggles distance counting on and off.
Freeze	Toggles Freeze mode on and off. When Freeze mode is active, the display is not updated but the counters continue to operate in the background.
Stopwatch	Controls the stopwatch.
Display Mode	Same effect as the MODE button in the Telemetry Screen.
Backlight Dim	When the input is held low the backlight intensity is reduced.
Count Up/Dn	When the input is held low the distance counters will count down.
* Stage Recorder	See page 34.
* Speed Alarm	See page 35.

** Available on G-200 model only.*

Stage Recorder (G-200 only)

This useful feature allows you to record your stage time, distance, average and maximum speed values using an external input switch. It is enabled by configuring the Auxiliary B input for 'Stage Record' mode (see page 32).

To use the recorder press and hold the external switch for one second while waiting on the start line. This will arm the system and clear the counters and stopwatch. When the vehicle begins moving the stopwatch will start automatically. At the end of the stage press the switch again and the stage information will be recorded.

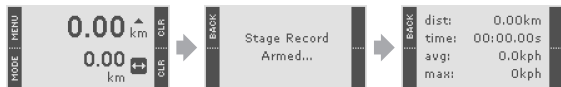

You can review the last stage's information at anytime by navigating to the 'Stage Record' display in the main menu.

Speed Alarm (G-200 only)

The Auxiliary A port can be used to drive a warning light when the vehicle exceeds a programmable speed. This is ideal for events with speed controls or on touring stages.

To activate the feature configure the Auxiliary A port in 'Speed Alarm' mode (see page 32) and fit a Monit warning light (available separately). Once this is done a new icon will appear in the main menu allowing you to set the trigger speed and enable or disable the alarm.



Calibration Value Adjustment (GPS disabled)

In wheel speed sensor mode the calibration value is stored as the number of pulses produced for every kilometre/mile travelled. If you share the device between vehicles, or change tyre sizes frequently, you may want to view and edit this value manually.

To view the calibration value select Calibration > Value.

To edit the calibration value (only possible if GPS is disabled):

1. Select Calibration > Value.
2. Press the EDIT button.
3. Enter the new value. Use the '+' and '-' buttons to adjust the highlighted digit and the '>' button to move between digits. When the last digit is reached press the SET button to finish.

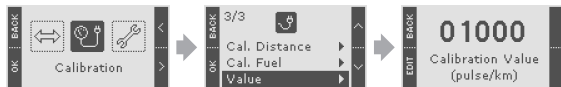

Counting Direction

The distance counters can be configured to count either up or down. To change the direction select Settings > Advanced > Counting. You can also use an external switch to control this setting (page 32).

Display Resolution

The distance counters normally have a resolution of ten metres. If you require a higher level of accuracy this can be increased to one metre. To change this select Settings > Advanced > Resolution.

Sleep Timer

The device will automatically enter a low power sleep mode after five minutes of inactivity. This can be adjusted by selecting Settings > Advanced > Sleep.

Note: Take care to ensure your vehicle's battery does not run flat if you disable the Sleep Timer.

Restoring Factory Defaults

To restore all settings to their default factory values navigate to the About menu and hold down the two buttons on the right of the screen for five seconds.

Warning: You will lose all calibration values when this is done.

Troubleshooting

If you're having trouble getting fuel or distance measurements working, read through this section for solutions to some common problems. And if you can't find an answer here, don't hesitate to contact Monit directly for help.

Common Problems:

I'm using a wheel sensor and the distance measurements are not consistent / increment while stationary.

When GPS is disabled the G-100/200 measures distance by counting the pulses produced by a wheel speed sensor. Noise from other parts of your vehicle's electrical system can interfere with this signal and cause measurement errors.

To solve the problem:

- Ensure that the G100/200, speed sensor and any attached switches are all grounded directly to a ground point on the vehicle's engine management computer. Do not use the vehicle's chassis.
- Physically move the G-100/200 wiring away from other wires in your vehicle.

The fuel level changes when I turn my engine on and off

The output signal from some fuel senders is proportional to the vehicle's battery voltage. When the engine is running this voltage is boosted by the alternator and this can cause changes in the fuel reading.

To solve the problem:

- If you will usually be checking the fuel level when the engine is running, calibrate the system with the engine running.
- Some after-market fuel senders will not have this problem. Check if your local motorsport dealer has a sender with a more stable output.

The fuel level measurements are not accurate

If the fuel sender in your vehicle does not generate a good quality signal, the G-200 will not be able to make accurate measurements. Unfortunately many factory senders are designed for low cost, not accuracy and you may have to fit an after-market sensor if you require better performance.

Error Messages:

'Error: No pulses detected'— No pulses are being detected from the wheel speed sensor during calibration. Check your connections and the instructions supplied with the sensor.

'Error: Too many pulses' — Too many pulses are being generated by the wheel speed sensor during calibration. Fit a pulse divider unit (available from Monit). This error can also be caused by electrical interference (see page 34).

'Error: Level must increase between set points.'— The amount of fuel you specified for this set point is less than what you specified for the previous one. Check your calculations.

'Error: Maximum number of set points reached.'— The G-200 can store a maximum of ten fuel set points. Repeat the calibration using an increased amount of fuel between each set point.

'Error: Invalid Fuel Signal. Refer to user's manual.'— The fuel sender is not producing monotonic (doesn't move in one direction) output signal during calibration.

To solve the problem:

- On many factory fuel tanks the fuel sensor is not very sensitive. Repeat the test but this time add more fuel between each set point.
- The fuel may take some time to settle in the tank when added. Repeat the calibration but this time wait at least 30 seconds after adding fuel before you record each set point.

Also note that some senders will not produce an output signal unless the vehicle's ignition is turned on.

© Monit Limited

<http://www.monitrally.com>